

***swissauto***  
***250***

**! IMPORTANT NOTICE!**

This engine is designed strictly for competition purposes only.

The manufacturer **SWISSAUTO** declare that all spare parts and engines are not covered by any warranty.

Only **SWISSAUTO** can recognize the manufactured defect after control.

The authoritative manual in case of discrepancy is the manual on the website

[www.swissauto.com](http://www.swissauto.com)

**Assembly Instructions  
and  
Operating Manual**

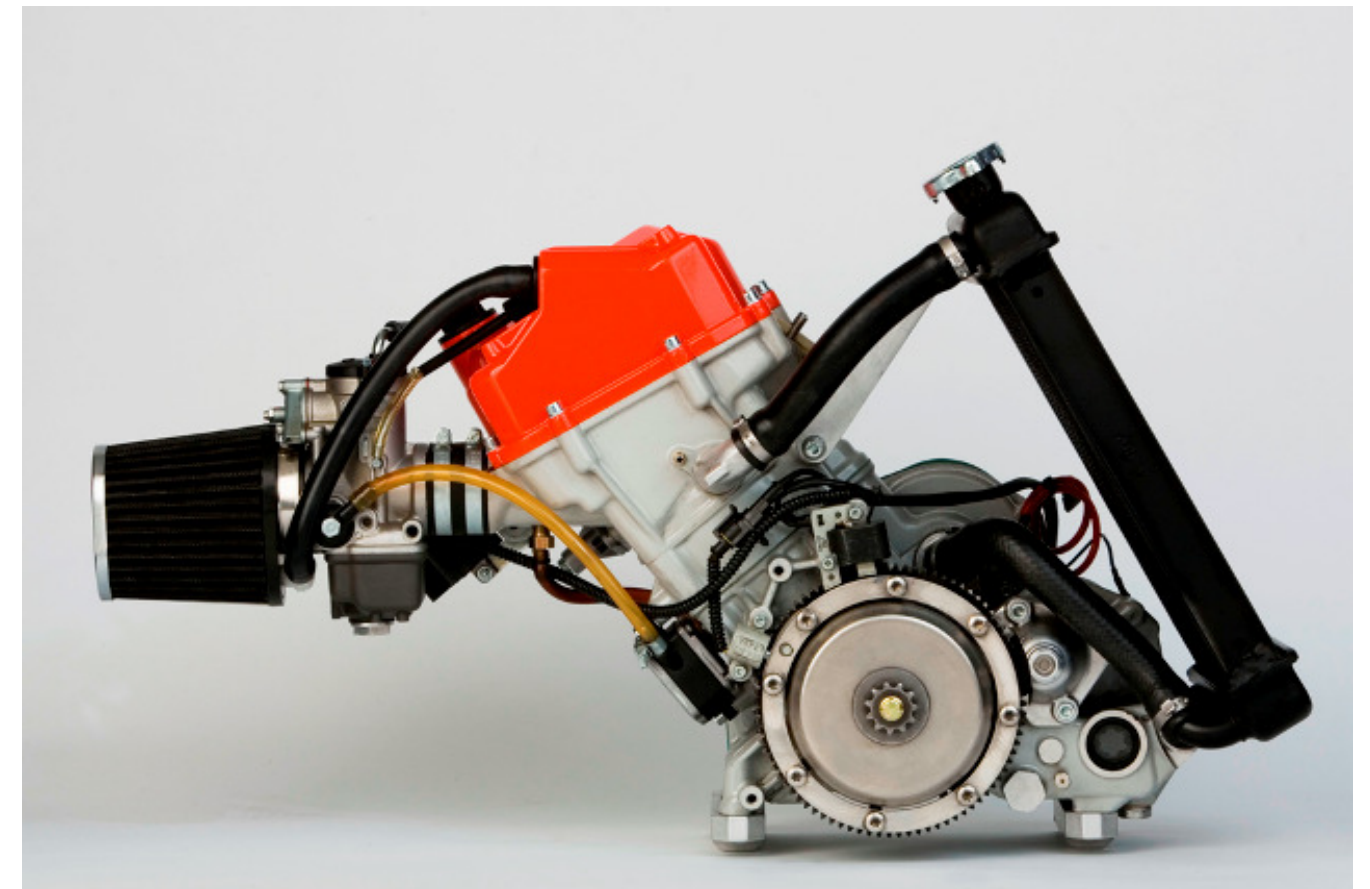

# Contents

All indications and procedures described in this manual are up to date at the time of publication and have been defined to the best of one's knowledge, however excluding any liability.

All rights reserved. Subject to technical modification. Errors expected. Reproduction, translation or distribution of this publication, even in extracts, only with prior written permission of:



2	Scope of Supply
3	Installation onto the Go-Kart
13	Start-up
15	Maintenance
17	Special Tools
18	Recommended Accessories
19	Tips and Tricks
20	Dismantling the Clutch
21	Assembling the Clutch
24	Wiring Plan
25	Basic Settings of the Carburetor
26	Table Main Jets
27	Table Gear Ratios
28	Table Tightening Torque
29	Technical Data



Buchmattstrasse 46 - 48  
3400 Burgdorf  
Schweiz  
[www.swissauto.com](http://www.swissauto.com)

**Customer's name**

**Engine number**

**Your official dealer**

# Technical Data

Engine	1 cylinder 4 stroke with balance shaft
Cooling	Water cooling, water cooling pump integrated in the engine block
Engine casing	Aluminium permanent mold casting
Cylinder	Aluminium permanent mold casting with Nikasil cylinder sleeve
Bore / Stroke	75 / 56.5 mm
Displacement	249.6 ccm
Power	35 / 39 HP at 10'000 1/min with 30 / 34 mm carburetor
Cylinder head	4 valves per cylinder, 2 overhead camshafts, mounted on roller bearings
Crankshaft	Forged steel shaft, press fitted, mounted on roller bearings
Piston	Aluminium forged
Connecting rod	Steel forged, mounted on roller bearings
Lubricating system	Integrated dry sump with diaphragm pump
Ignition	Digital magneto with rev limiter
Carburetor	Dell'Orto D = 30 mm / 34 mm
Fuel pump	Vacuum pump integrated into the engine casing
Transmission	Gearless drive with centrifugal clutch and chain drive
Main dimensions	L/W/H = 410/190/330 mm
Weight	15 kg incl. starter
Spark plug gap	0.6 mm
Distance primary coil	1.2 mm to magneto
Distance pick-up	1.2 mm to counter weight

# Scope of Supply

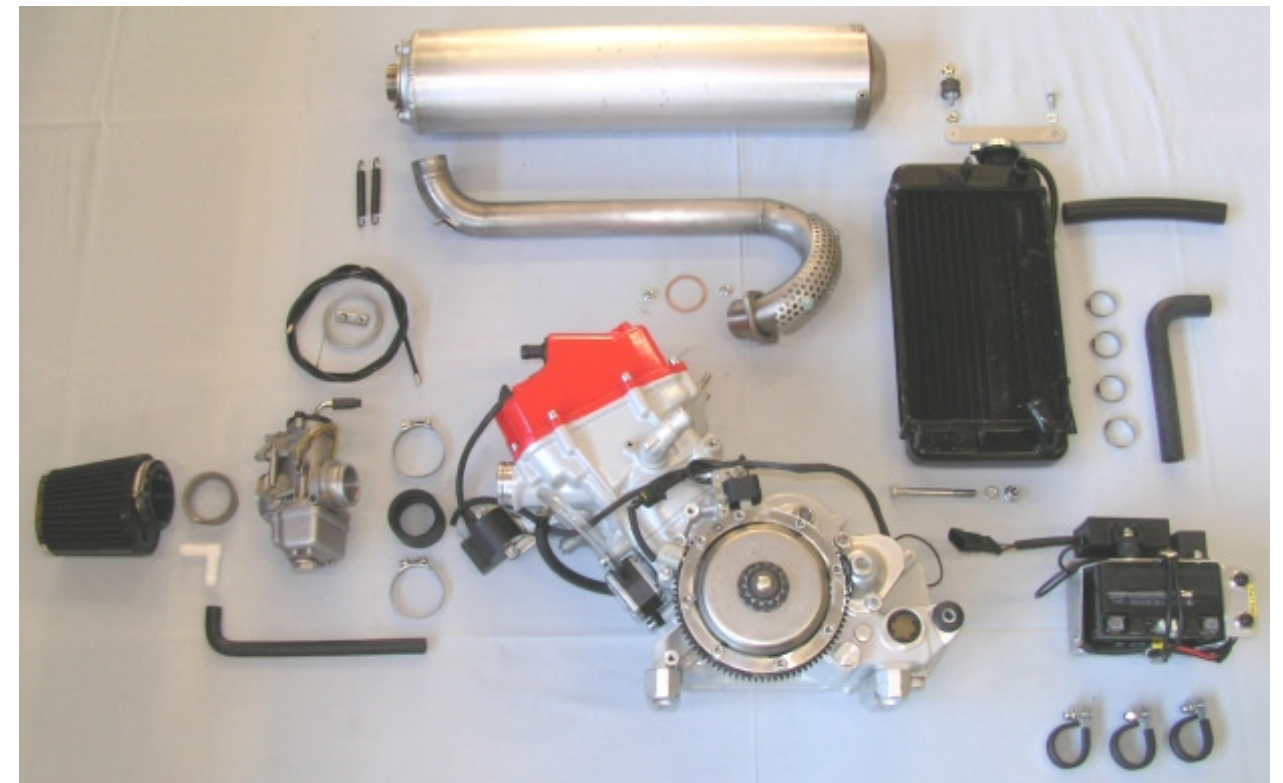

- engine ,swissauto 250' with clutch, ignition and fuel pump
- radiator
- radiator support with silent blocks, bolts and nuts
- 2 cooler hoses
- 3 hose clamps 27.1
- 1 hose clamp 28.6
- carburetor
- carburetor rubber
- 2 hose clamps for carburetor rubber
- air filter flange
- air filter incl. clamp
- crankcase ventilation hose with ventilation tube 90°
- ignition coil with spark plug boot
- battery box with battery, relay and cabling
- control unit
- 3 pipe clamps with bolts and nuts
- primary tube with gasket and nuts
- exhaust silencer
- 2 silencer springs
- throttle cable (inner wire and sleeve)
- clamp for throttle cable

# Installation onto the Go-Kart

**Step 1:** Complete the engine by assembling the ignition coil, the radiator and the carburetor. Charge the battery!



Put the ignition coil onto the two silent blocks on the cylinder head.



Put the ground cable onto the stud of the lower silent block.



Mount both flange nuts and tighten the nuts with 10Nm.

Insert the spark plug boot into the plug hole and push it onto the spark plug.



Lead the primary cable behind the hose nipple.

Plug in the primary cable from the primary coil on the corresponding position on the ignition coil.

# Table Tightening Torque

<u>Tightening Torque</u>		Loctite	Thread	Strenght	Nm
Engine mount	allen screw	243	M8	8.8	22
Transmission sprocket bolt	hexagon with flange		M6	8.8	13
Transmission sprocket nut	hexagon		M28x1		110
Clutch mount nut	hexagon		M24x2		150
Spark plug	A/F 16		M10x1		12
Pick-up	allen screw		M4	8.8	3
Primary coil	allen screw		M4	8.8	3
Mounting bolt for oil filter	hexagon		M14x1.5		26
Oil drain plug	hexagon (magnetic)		M14x1.5		26
<b><u>CLUTCH:</u></b>					
Starter sprocket with clutch mount	hexagon		M 8	10.9	22
Starter sprocket with clutch mount	hexagon		M 7	8.8	22
Starter sprocket with support ring	allen screw		M 6 stainless steel		10

# Table Gear Ratios

Top Speed at 13'000 rpm

Transmission sprocket	Rear sprocket	Top Speed [km/h]	Transmission sprocket	Rear sprocket	Top Speed [km/h]
11	90	83.9	14	88	109.2
11	89	84.8	13	81	110.2
11	88	85.8	14	87	110.5
11	87	86.8	13	80	111.5
11	86	87.8	14	86	111.7
11	85	88.8	13	79	113.0
11	84	89.9	14	85	113.1
11	83	91.0	13	78	114.4
11	82	92.1	14	84	114.4
11	81	93.2	14	83	115.8
11	80	94.4	13	77	115.9
11	79	95.6	14	82	117.2
11	78	96.8	13	76	117.4
11	77	98.1	14	81	118.6
13	90	99.1	13	75	119.0
11	76	99.3	14	80	120.1
13	89	100.3	13	74	120.6
11	75	100.7	14	79	121.6
13	88	101.4	13	73	122.2
11	74	102.0	14	78	123.2
13	87	102.6	13	72	123.9
11	73	103.4	14	77	124.8
13	86	103.8	13	71	125.7
11	72	104.9	14	76	126.4
13	85	105.0	13	70	127.5
13	84	106.2	14	75	128.1
11	71	106.3	14	74	129.9
14	90	106.8	14	73	131.6
13	83	107.5	14	72	133.5
11	70	107.9	14	71	135.3
14	89	108.0	14	70	137.3
13	82	108.8			

# Installation onto the Go-Kart

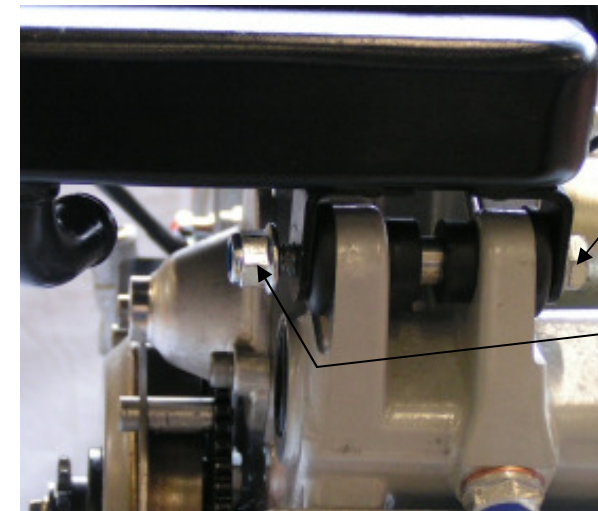

Bolt M8x80 with washer

Self-locking flange nut M8

Tighten with 12Nm.

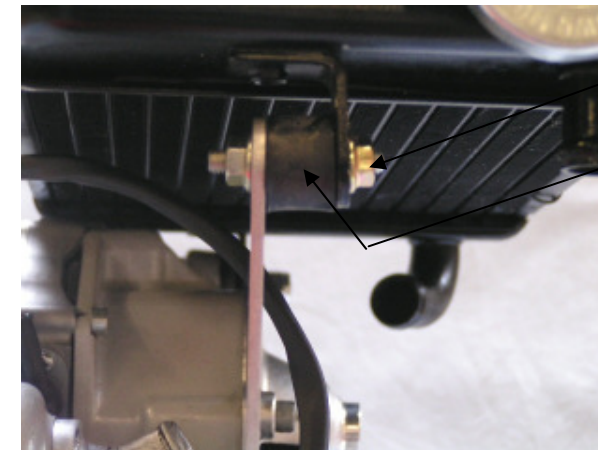

2x flange nuts M6

Silent block 20x10 M6x12/12

Tighten with 10Nm.

Avoid distortion of the silent block during installation of cooler hose up. Otherwise shorten the cooler hose accordingly.

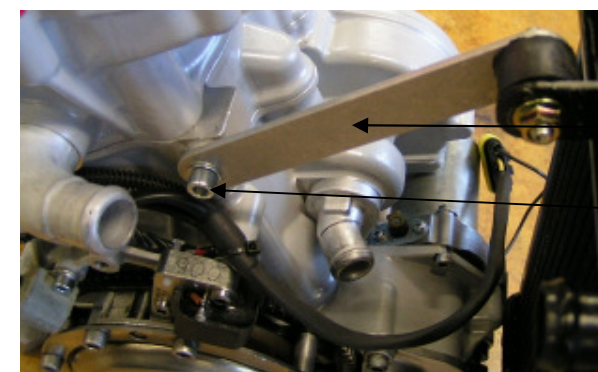

Radiator support

Bolt M6x16 with washer  
Tighten with 10Nm.

# Installation onto the Go-Kart

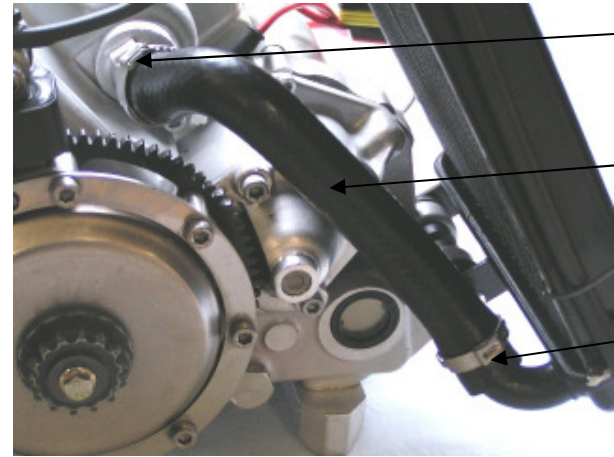

Hose clamp 28.6

Cooler hose below

Hose clamp 27.1

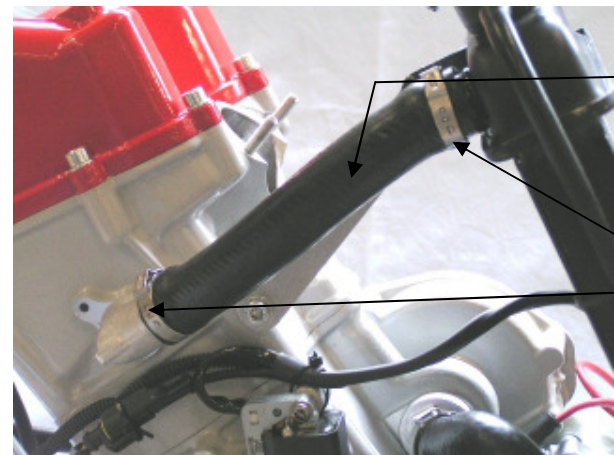

Cooler hose up

2x hose clamps 27.1



Squeeze all 4 hose clamps with a pliers.

# Table Main Jets

Air temperature [°C]	>1000		800		500			300			0				Height above sea level air pressure [mbar]
	900	910	920	930	940	950	960	970	980	990	1000	1010	1020	1030	
	0	104	104	106	106	106	106	108	108	108	108	110	110	110	
2	104	104	104	106	106	106	108	108	108	108	110	110	110	112	
4	104	104	104	106	106	106	106	108	108	108	110	110	110	110	
6	104	104	104	106	106	106	106	108	108	108	110	110	110	110	
8	104	104	104	104	106	106	106	108	108	108	108	110	110	110	
10	104	104	104	104	106	106	106	106	108	108	108	110	110	110	
12	102	104	104	104	106	106	106	106	108	108	108	108	110	110	
14	102	104	104	104	104	106	106	106	108	108	108	108	110	110	
16	102	104	104	104	104	106	106	106	106	108	108	108	110	110	
18	102	102	104	104	104	106	106	106	106	108	108	108	108	110	
20	102	102	104	104	104	104	106	106	106	108	108	108	108	110	
22	102	102	104	104	104	104	106	106	106	106	108	108	108	110	
24	102	102	102	104	104	104	106	106	106	106	108	108	108	108	
26	102	102	102	104	104	104	104	106	106	106	108	108	108	108	
28	100	102	102	104	104	104	104	106	106	106	106	108	108	108	
30	100	102	102	102	104	104	104	106	106	106	106	108	108	108	
32	100	102	102	102	104	104	104	104	106	106	106	108	108	108	
34	100	102	102	102	104	104	104	104	106	106	106	106	108	108	
36	100	100	102	102	104	104	104	104	106	106	106	106	108	108	
38	100	100	102	102	102	104	104	104	106	106	106	106	108	108	
40	100	100	102	102	102	104	104	104	104	106	106	106	106	108	

 Standard main jet at delivery

**These are the main jets for the carburetor Dell'orto PHF 30**

# Basic Settings of the Carburetor

## Carburetor Dell'orto PHF 30 DD1

<b>Main jet</b>	<b>106</b>
<b>Idle jet</b>	<b>55</b>
<b>Inner venturi</b>	<b>BF1</b>
<b>Needle jet</b>	<b>AB 260</b>
<b>Needle</b>	<b>K29</b>
<b>Needle clip position</b>	<b>1 R.V.O.</b>
<b><u>Accelerator pump:</u></b>	
<b>Injection nozzle</b>	<b>38</b>
<b>Injection time</b>	<b>0.5 seconds = Diaphragm stop position 3 ¼ turns open</b>

# Installation onto the Go-Kart

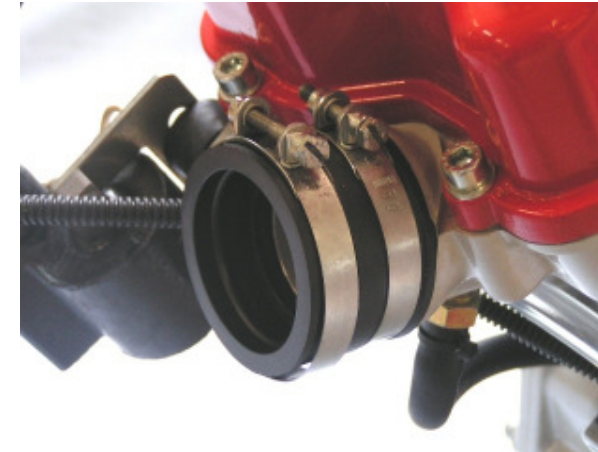

Put the two hose clamps onto the carburetor rubber and push the rubber onto the intake port.

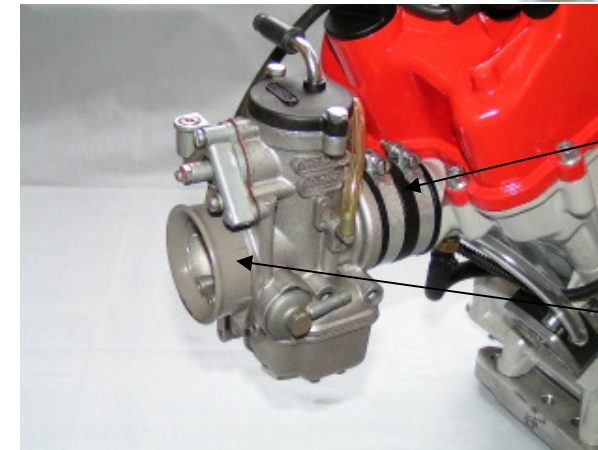

Put the carburetor into the carburetor rubber and tighten both hose clamps.

Check if the carburetor is positioned horizontally. Otherwise adjust carburetor position accordingly.



Install the air filter flange.

Pull the crankcase ventilation hose onto the ventilation tube and push the tube into the corresponding hole on the air filter.



Install the air filter onto the carburetor and tighten the hose clamp.

Connect the crankcase ventilation hose to the engine's ventilation tube.

Connect the gas line to the carburetor.

# Installation onto the Go-Kart

**Step 2:** Position the engine onto the go-kart.



Put the primary tube gasket into the primary tube port.

Install the primary tube loose with 2 flange nuts M6 in order to be able to position the primary tube.

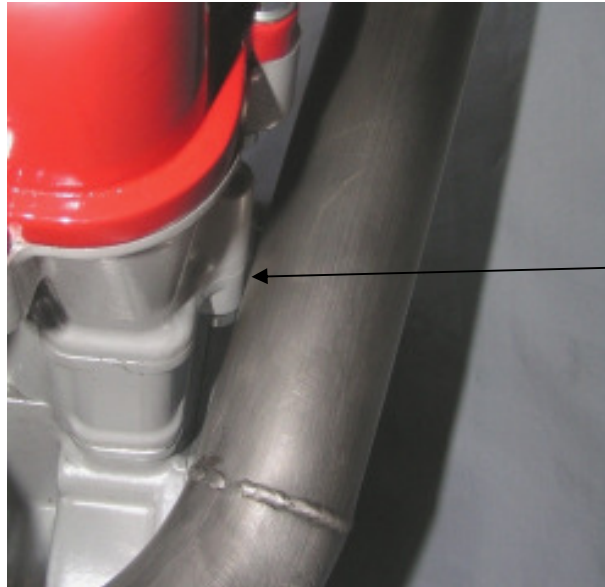

Position the primary tube in that way to leave a gap of 1mm. Tighten both nuts.

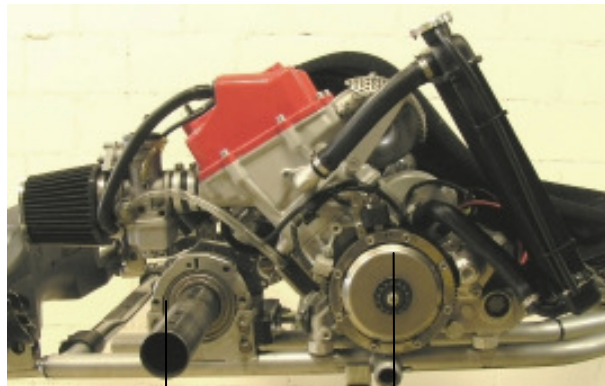

Now install the engine onto the go-kart. The distance from the middle of the rear axle to the middle of the crankshaft is 230mm.

ca. 230mm

# Wiring Plan

Wiring plan of the battery box.

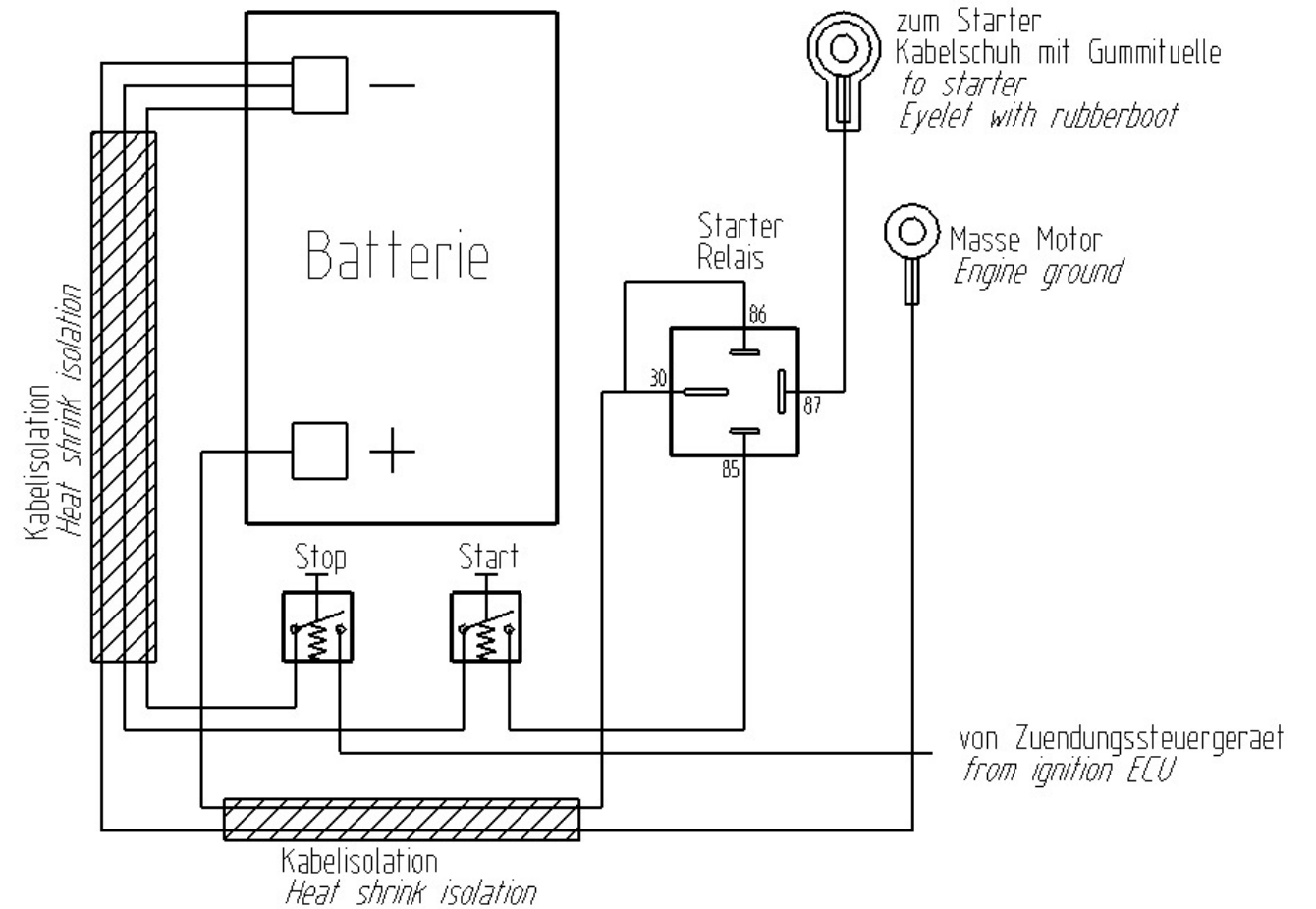



# Assembling the Clutch

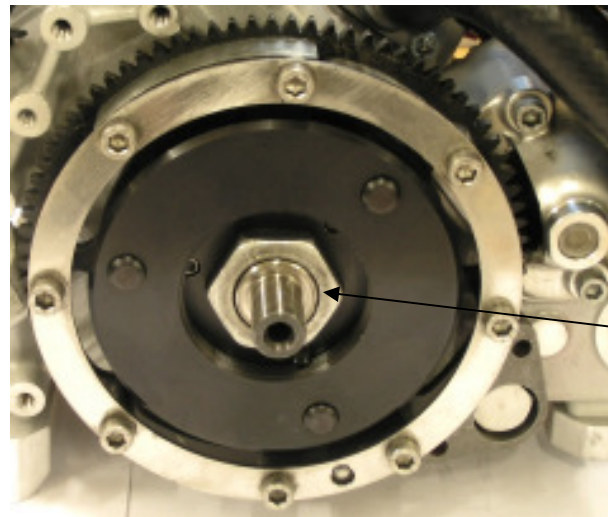

Install the clutch onto the crankshaft (do not forget the key).

Tighten the clutch mount nut with 150 Nm.

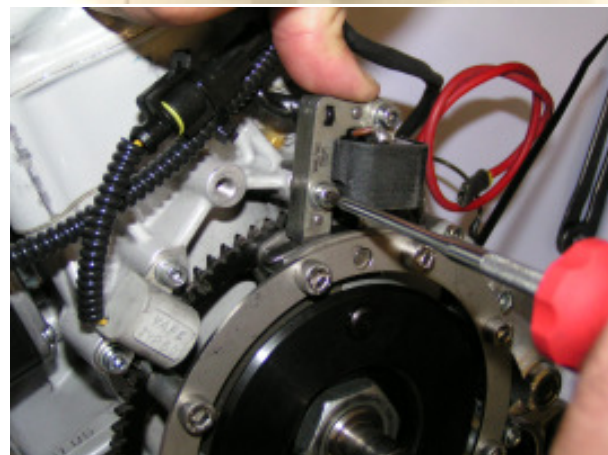

Slide the bent feeler gauge of 1.2mm between primary coil and magneto. Lock the clutch/crankshaft with the „BATMAN“-tool.

Loosen the primary coil and push it downwards. Tighten the primary coil bolts with 3Nm.

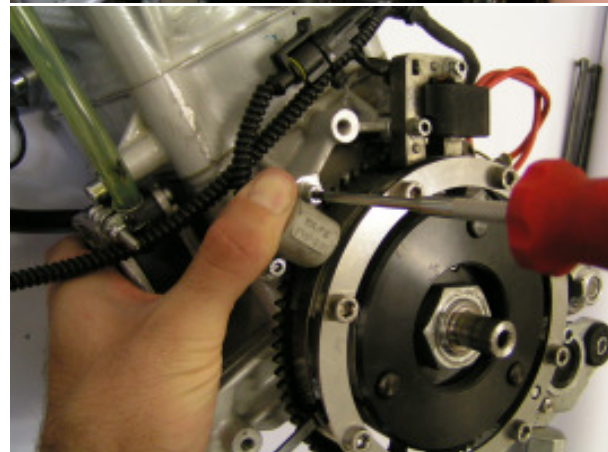

Remove the „BATMAN“-tool and turn the crankshaft till the counter weight and the pick-up are in line.

Adjust the required distance of 1.2mm with the feeler gauge, too. Tighten the pick-up bolts with 3Nm.

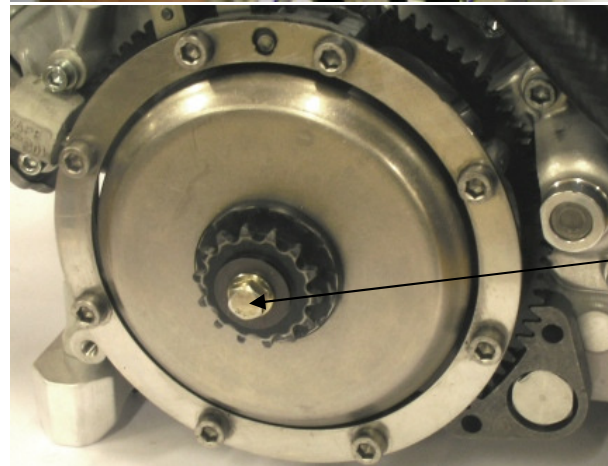

Install the clutch drum and the transmission sprocket bearing. Mount the „BATMAN“-tool.

Put on the transmission sprocket bolt M6 with the thrust washer and tighten the bolt with 13 Nm.

Remove the „BATMAN“-tool.

# Installation onto the Go-Kart

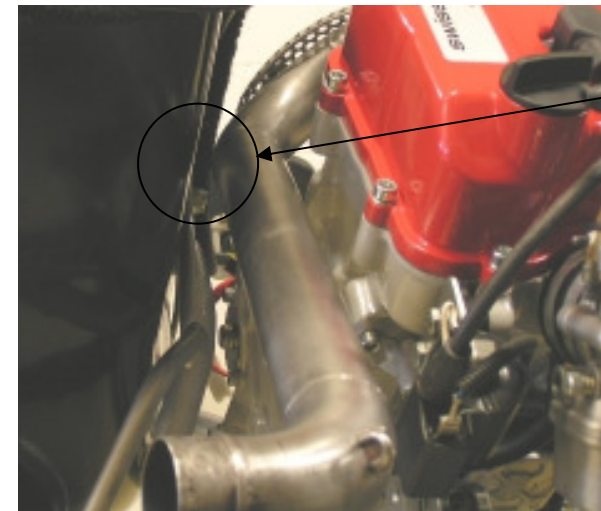

The distance between primary tube and driver seat should result in min. 2cm.

In case that the primary tube is too close to the seat or if you like a different engine position compared to the seat you can adjust the engine mount position accordingly.



## Standard position middle

At delivery the engine mounts are installed at the middle position.



## Position left

On the left position the engine is moved 15mm closer to the seat.



## Position right

On the right position the engine is moved 15mm off the seat.

The bolts of the engine mount have to be tightened with **Loctite 243** and 22Nm torque.

# Installation onto the Go-Kart

## Step 3: Install the battery box.

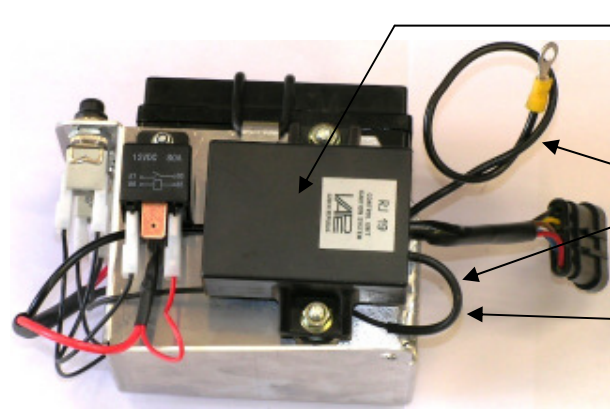

Install the control unit onto the two silent blocks and tighten both flange nuts M6.

Lead the stop cable and the engine ground cable behind the control unit.

Plug in the stop cable on the free position on the stop switch.

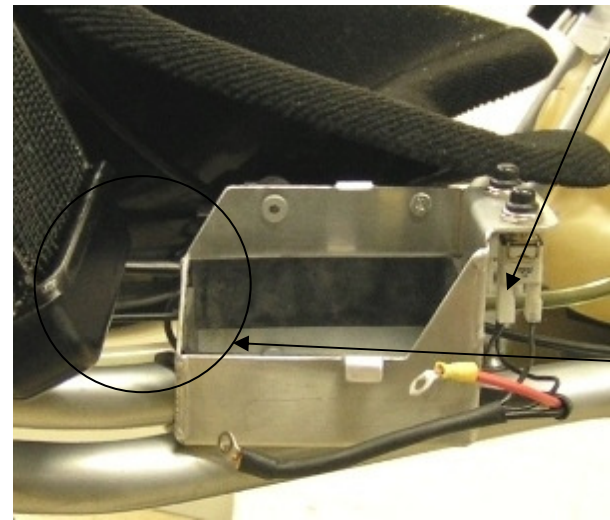

Remove the battery and the rubber floor.

Position the battery box in front of the radiator.

The distance to the radiator should result in 3-4cm in order to avoid problems when adjusting the chain.

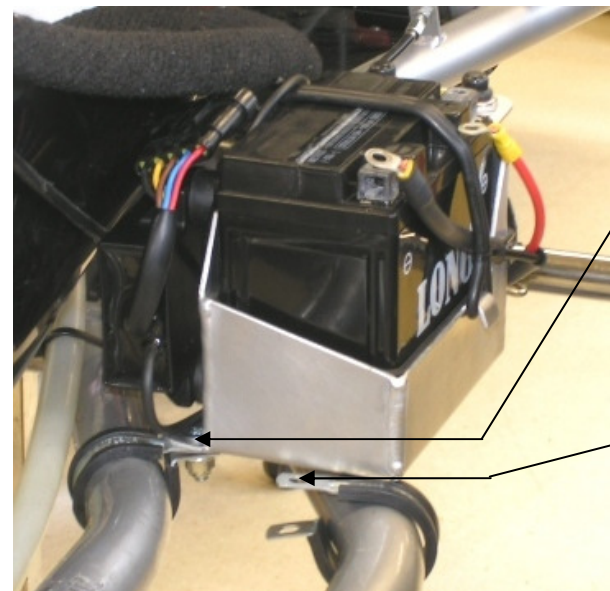

Fix the battery box with the first tube clamp onto the frame.

The other two tube clamps have to be positioned according to the tube's design. Based on this position the corresponding holes have to be drilled.

For doing this put the clamps onto the frame and mark the hole position. After having mounted all 3 tube clamps reinstall the rubber floor and the battery.

# Assembling the Clutch

Put the clutch mount onto the starter sprocket. Align the key slot in that way to point 9.5° away from the counter weight (see picture below).

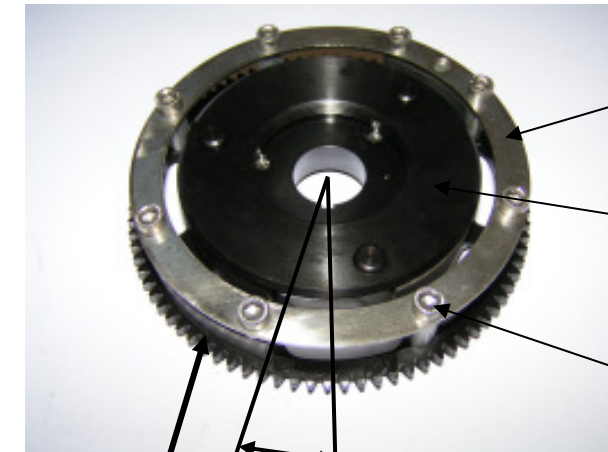

Counter weight

9.5 degrees

Tighten the unit with 3 bolts M7 and 3 bolts M8 by applying a torque of 22Nm.

## Installation of primary coil and pick-up sensor

Mount the primary coil and the pick-up sensor provisionally onto the casing. During tightening pull these parts away from the crankshaft centre. Turn the crankshaft to the position where magneto and coil are in line.

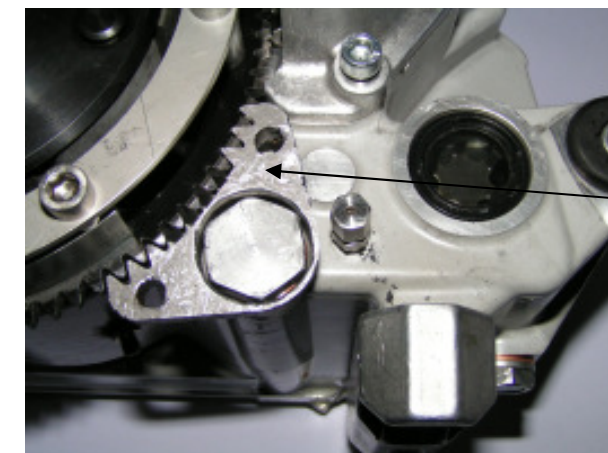

Lock the clutch with the special tool „BATMAN“.

# Assembling the Clutch

## Pre-assembly of the clutch

Position the magneto on the starter sprocket in that way that the arrow is pointing in rotating direction of the engine. The larger chamfer on the teeth must point downward.

Now put the counter weight, the 2 short and the 4 long spacers onto the starter sprocket.

arrow – rotating direction / right

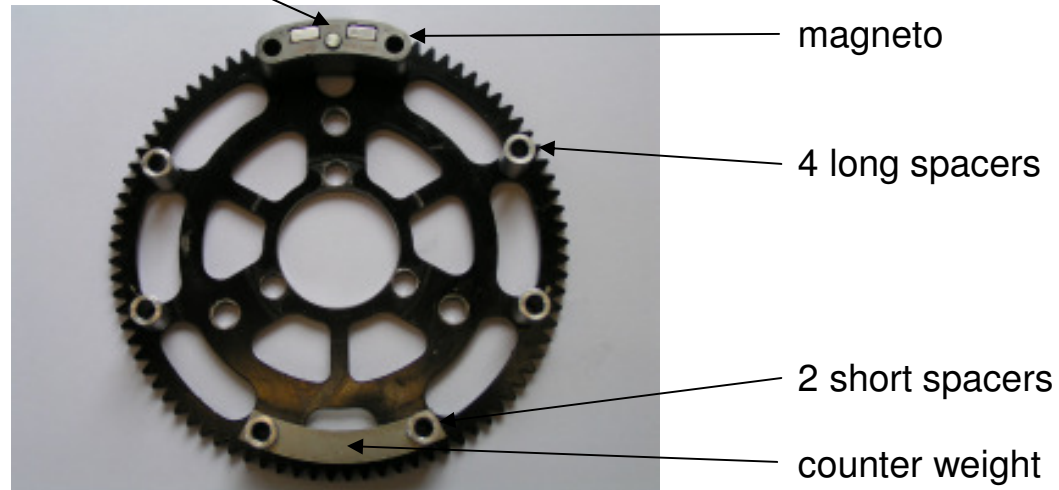

Put the supporting ring with the 9 holes onto the sprocket and tighten the unit with 8 stainless steel M6 bolts by applying a torque of 10Nm.

### **IMPORTANT:**

Magneto and counter weight should both be pushed outwards when tightening.

### **IMPORTANT:**

Apply stainless steel bolts only, otherwise the ignition will not work.

# Installation onto the Go-Kart

## Step 4: Wiring

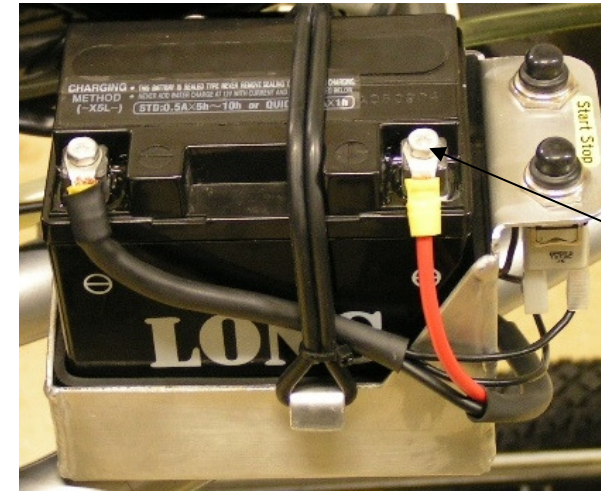

Connect the plus and the minus cable on the battery with the provided slot nuts and bolts.

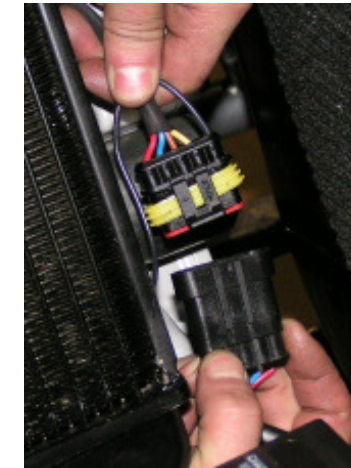

Connect the engine wiring harness to the control unit on the battery box.

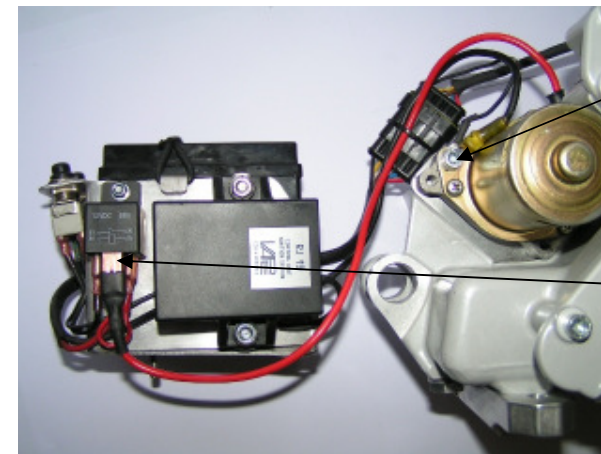

Connect the engine ground cable (black) to the engine.

Plug in the starter cable (red) on the free position on the starter relay.

# Installation onto the Go-Kart

## Step 5: Install the exhaust silencer



Install the exhaust silencer on a commercially available exhaust bracket (not included in the scope of supply).

Make sure that the silencer is in line with the primary tube. The silencer should be installed horizontally. If necessary, loose the nuts on the primary tube in order to adjust the correct position.

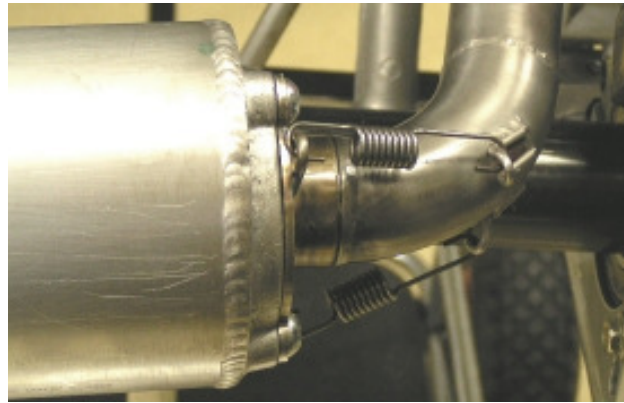

Connect the exhaust silencer and the primary tube with the 2 enclosed silencer springs.

Retighten the nuts on the primary tube.

## Step 6: Fuel hose



Lead the gas line to the fuel pump and connect it to the free position on the fuel pump.

# Dismantling the Clutch

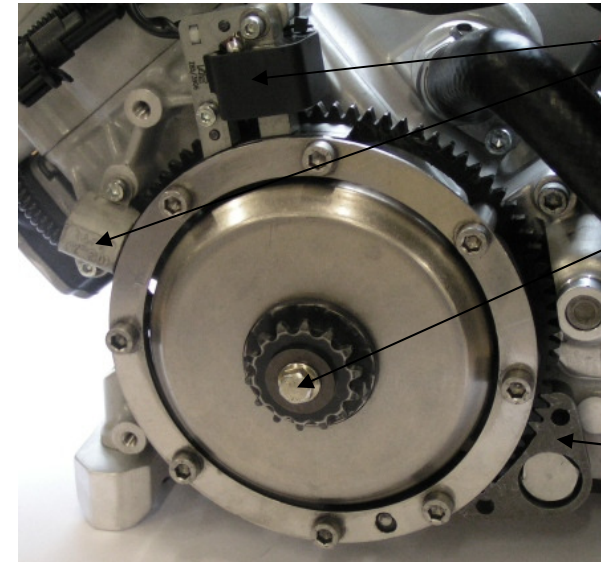

Dismantle the primary coil and the pick-up sensor.

Loosen the transmission sprocket bolt. Remove the clutch drum and the sprocket bearing.

Lock the clutch/crankshaft with the „BATMAN“-tool.

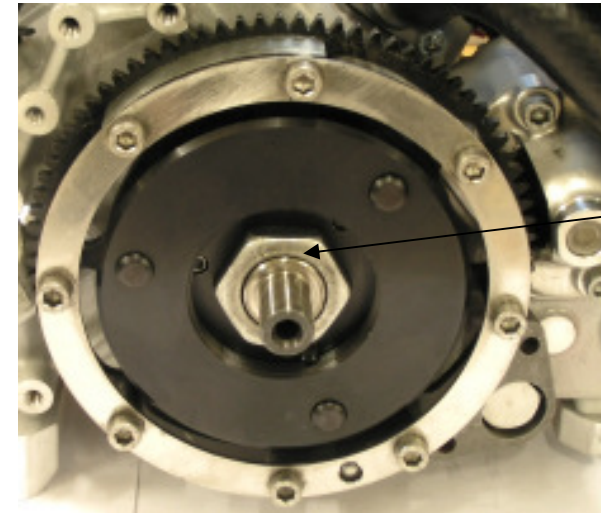

Loosen the clutch mount nut.

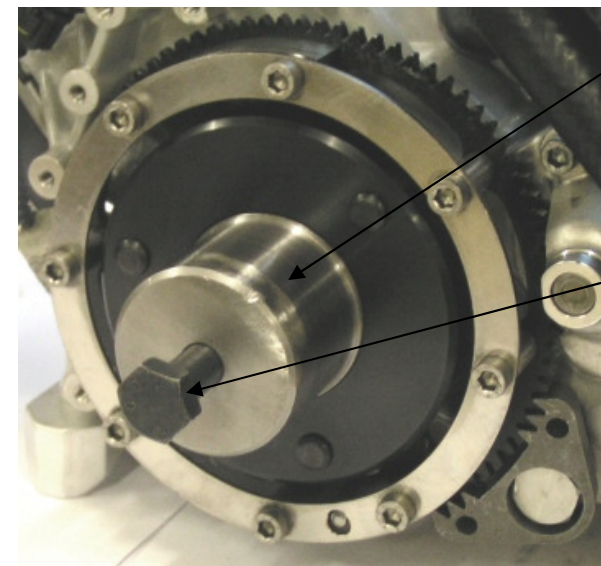

Screw in the clutch puller into the clutch mount by hand as far as possible.

Tighten the bolt till the clutch is pulled away from the crankshaft.

# Tips and Tricks

- **How to find out the correct gear ratio**

Choose the gear ratio in that way to run into the rev limiter for min. 1 second at the end of the longest straight of the present race track.

- **How to find out the correct carburetor adjustment**

Please consider the enclosed main jet table. Ambient air pressure and temperature have an influence on the choice of the carburetor nozzles.

- **Scratches on the exhaust muffler**

Conventional exhaust brackets from most of the go-kart manufacturers cause scratches on the exhaust muffler due to the springs. To avoid this we recommend to apply a protecting rubber.

- **Lubricate chain and transmission sprocket bearing before every ride**

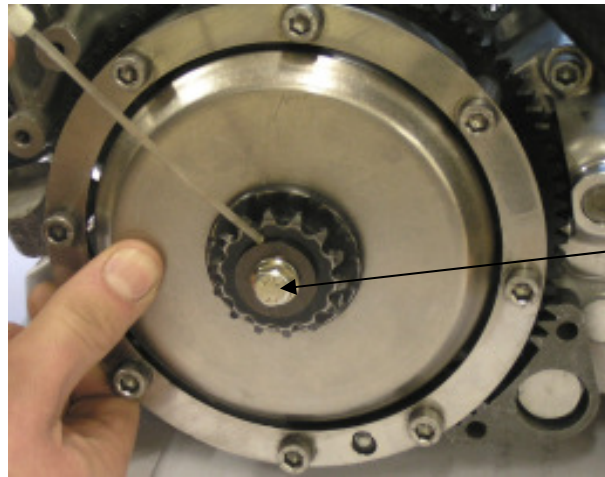

Push the clutch drum backwards and apply chain spray between transmission sprocket and thrust washer.

- **The clutch is not suited for standing race starts**

Avoid starting at high speeds, otherwise the clutch is heated up heavily and worn out badly.

On a race track with a high end speed the starting procedure with high revolutions increases the load on the clutch additionally!

- **For a fast change of the gear ratio we recommend an additional clutch drum with a pre-mounted transmission sprocket.**

- **All manuals and spare parts lists can be found on our homepage:**

[www.swissauto.com](http://www.swissauto.com)

# Installation on to the Go-Kart

**Step 7:** Install the throttle cable.

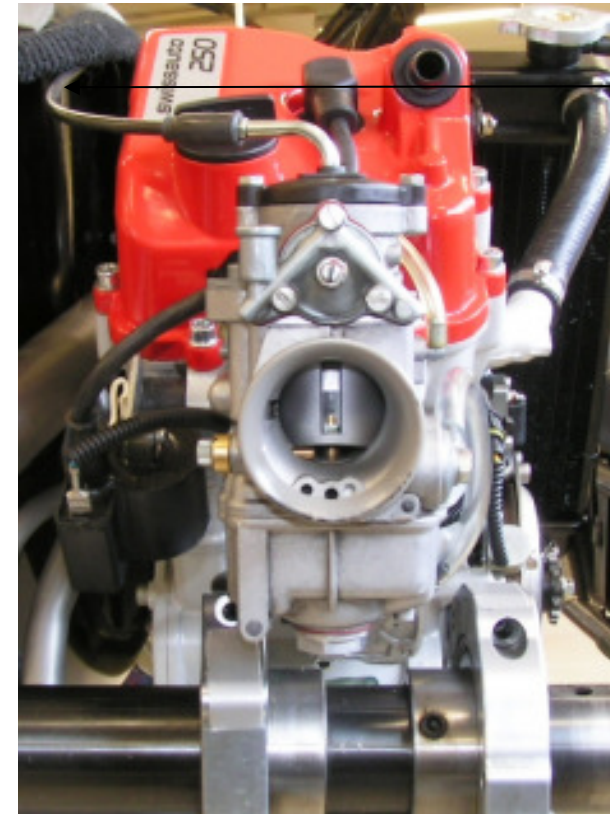

Install the inner wire of the throttle cable on the carburetor and lead the wire with the cable sleeve along the seat.

Lead the throttle cable in that way to have a sufficient distance to the exhaust manifold in order to avoid damage due to heat radiation from the exhaust manifold.

The throttle cable should be installed in that way to avoid tension on the wire at idle position. Otherwise the engine will not idle properly.



At full throttle position the slide must open completely.

The stop position on the pedal at full throttle must be adjusted in that way to avoid an overdraw of the slide.

# Start-up



Fill in 0.4l 0W30 motor oil from "Motorex" into the engine.



Fill in ca. 0.7l of water into the radiator.

**To avoid freezing of the cooling water (and therefore possible cracks on cooler or casing) during wintertime, remove the water!**

**Use only unleaded fuel with min. 95 octane.**

Fill the carburetor with gasoline by applying pressure onto the gas tank. Pull the choke lever on the carburetor and press the start button. Let the engine run for 10 seconds. Then switch it off and check the oil level.

The oil level should be now at or just slightly above the middle of the oil show glass. In case the oil level is too low fill it up.

# Recommended Accessories

These accessories are not included in the scope of supply.

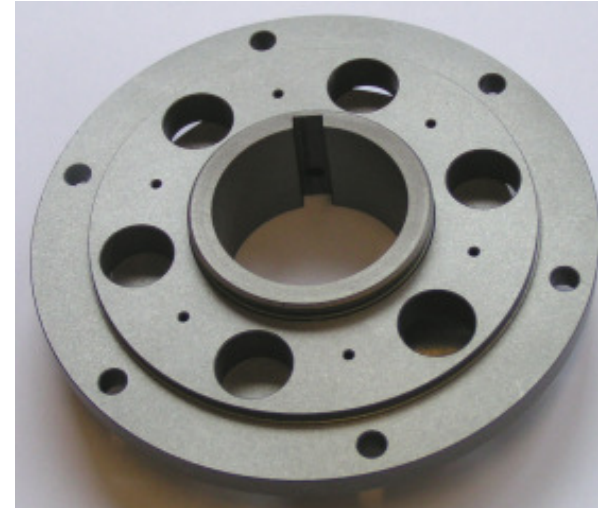

## **Torque absorber**

The torque absorber is a sprocket mount on the rear axle, which suits for all current rear sprockets.

This torque absorber considerably increases service life of the chain.



## **Air box**

The air box reduces noise emissions considerably - without any power losses.

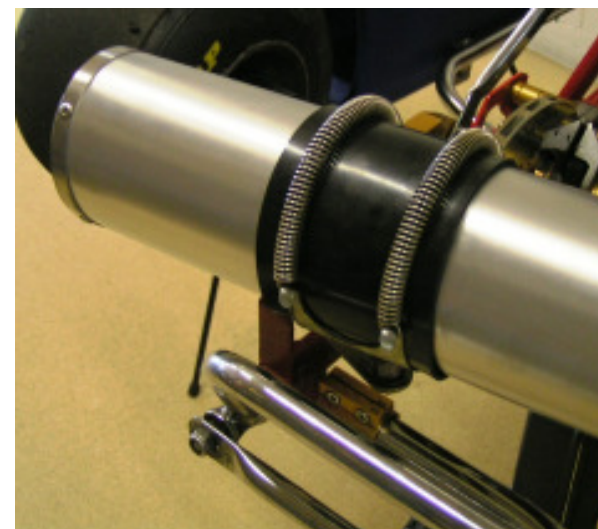

## **Protecting rubber**

The protecting rubber avoids scratches on the exhaust silencer originating from the exhaust bracket and the springs.

Besides we recommend to take a charged spare battery with you to the racing field.

# Special Tools

We recommend the following special tools:

- Clutch puller
- Clutch stop tool „BATMAN“
- Leaf metal ignition 1.2mm
- Sprocket key Z13

With these special tools the clutch and the transmission sprocket on the clutch drum can be dismantled and replaced.

These tools are not included in the scope of supply. Contact your dealer to get these tools.

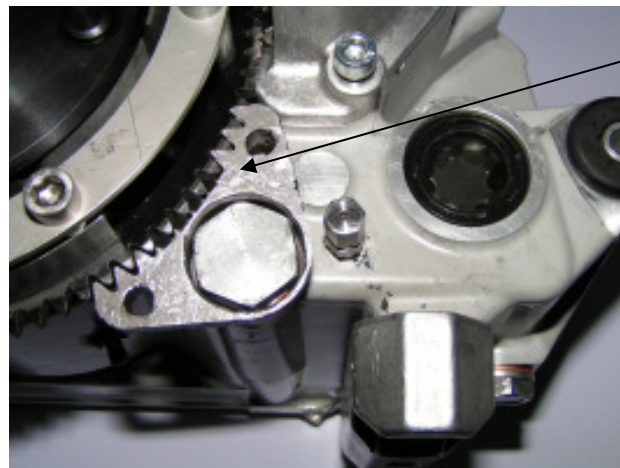

clutch stop tool  
„BATMAN“

# Start-up

If too much oil is present in the engine, the engine might eject the excessive oil by the crankcase ventilation hose into the air filter.

When the oil is warm the oil level should not pass the upper edge of the oil inspection glass. An air bubble should be still visible at the upper edge of the show glass.

If this is not the case then remove the excessive oil until the reference level is reached (see picture below).

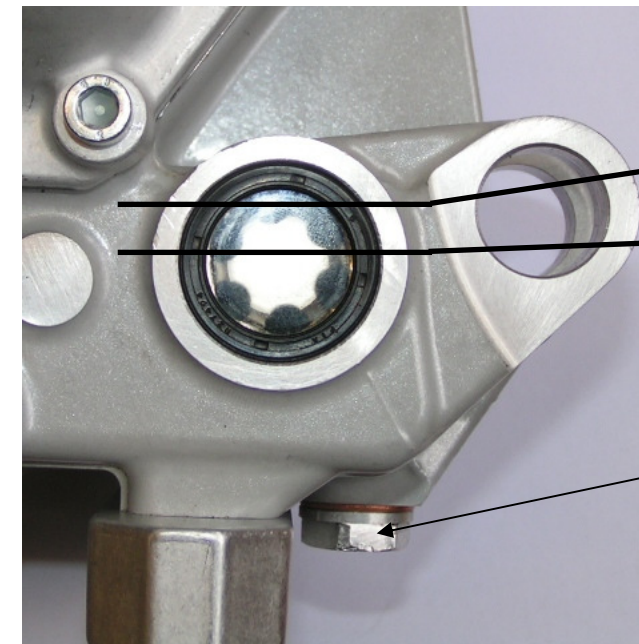

Max. oil level warm

Min. oil level warm

Oil drain plug

The cooling water system is self-venting. However, it is recommended to hold the hand on the radiator's surface during warm up in order to check if the radiator is heating up evenly.

During the drive, the cooling water temperature should be between 50-90°C. If the engine temperature is too low, cover the radiator in that way to achieve above mentioned temperature range.

**Breaking-in the engine for 2 hours. Do not run the engine above 11'000 rpm during this 2 hours.**

# Maintenance

The maintenance of the "swissauto 250 engine" is substantial for its service life.

If maintenance is carried out incorrectly or insufficiently the service life might be reduced.

Therefore certain mechanic knowledge is required.

If there are points which are not clear contact your dealer.

- **Battery is not self-charging**

Charge your battery before every training day. Otherwise you will not be able to start the engine without any help.

- **Check oil level before every ride**

If the oil level is too low you might risk to damage the engine.

If the oil level is too high oil is ejected and the air filter gets soiled.

- **When racing oil change is required every 1h or after every race, otherwise every 5h**

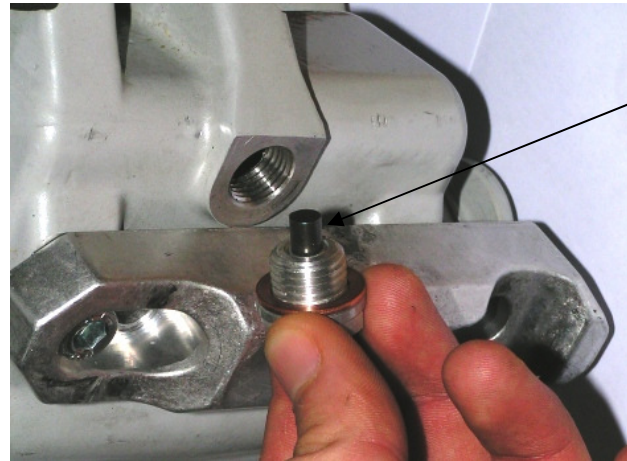

Remove the oil drain plug and clean the magnet on the bolt's end.

In case you observe excessive wear contact your dealer.

Keep pushing the stop button to avoid starting of the engine. Now push the start button in order to remove the remaining oil from the engine.

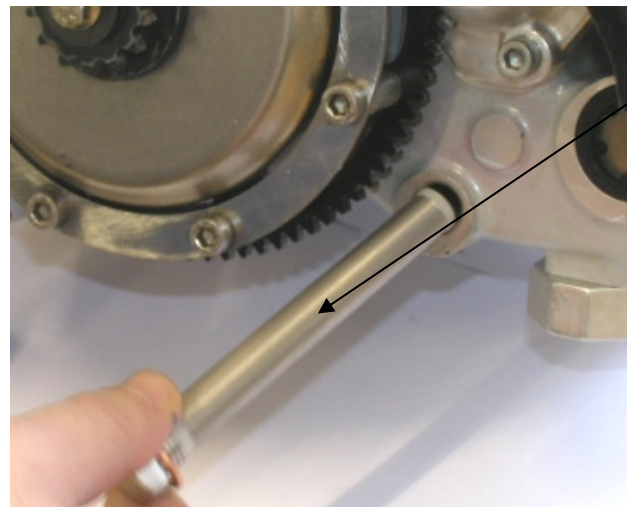

**Every second oil change**

remove the oil screen and clean it.

Remount the oil drain plug and tighten the bolt with 26Nm.

When installing the oil screen pay attention to hit the port in the oil chamber!

Tighten the bolt with 26Nm.

# Maintenance

- **Apply full synthetic oil 0W30**

We recommend lubricants from the company "Motorex".



- **Oil refill capacity**

After oil changing and service 0.4l.

After engine disassembling 0.6l.

- **Air filter cleaning every 5h**

A soiled air filter leads to considerable power losses. Clean the air filter with gasoline.

- **Check valve clearance after the first 10h**

Further checks of the valve clearance are not necessary.

Contact your dealer for carrying out this check.

- **General check at your dealer's shop every 40h**

Modifications on the maintenance timetable are possible. The current version of maintenance timetable you will find on our homepage:

[www.swissauto.com](http://www.swissauto.com)